

PL05138CAM - KL05138CAM

PORTAVALIGIE LATERALE SPECIFICO - SPECIFIC TUBULAR SIDE-CASE HOLDER - PORTE-VALISES LATÉRAUX SPÉCIFIQUE
SPEZIFISCHES STAHLROHR-SEITENTRAEGER - PORTA MALETAS LATERALES ESPECÍFICO - SUORTE DE MALAS ESPECÍFICO

BMW S1000XR (2020)

N°	Descrizione/Description	Caratteristiche/Features	Codice/Code	Quantità/Quantity
1	Telaio laterale - Side frame - Châssis latéral - Soporte lateral - Seitenrahmen - Suporte lateral	-	PL05138DXV PL05138SXV	2 (Right: Left)
2	Ponte Di Collegamento Posteriore - Rear Bridge - Pont Posterieure Verbindungsrohr - Puente Trasero	-	GL4530V	1
3	Supporto anteriore - Front support -Support avant Vordere Unterstützung - Soporte frontal - Suporte frontal	-	GL4528SX GL4528DX	2 (Right: Left)
4	Supporto posteriore - Rear support - Hintere Unterstützung Support arrière - Soporte trasero - Suporte traseiro	-	GL4529SX GL4529DX	2 (Right: Left)
5	Vite - Screw - Vis - Schraube Tornillo - Parafuso	TBEI M8x55	855TBEI	4
6	Vite - Screw - Vis - Schraube Tornillo - Parafuso	TBEI M8x50	850TBEI	4
7	Vite - Screw - Vis - Schraube Tornillo - Parafuso	TCE M5x20	520TCE	8
8	Vite - Screw - Vis - Schraube Tornillo - Parafuso	TBEI M8x25	825TBEI	8
9	Vite - Screw - Vis - Schraube Tornillo - Parafuso	TBEI M5x35	535TBEI	2
10	Rondella - Washer - Rondelle Scheibe - Arandela - Arruela	Foro Ø8,5mm Esterno Ø20mm Sp. 2mm	820RON	8
11	Rondella - Washer - Rondelle Scheibe - Arandela - Arruela	Foro Ø8mm Esterno Ø14mm	814RON	8
12	Rondella spaccata - Split washer - Scheibe Rondelle fendue - Arandela seccionada - Arruela Dentada	Foro Ø5mm	Z1049	2
13	Rondella - Washer - Rondelle Scheibe - Arandela - Arruela	Foro Ø5mm Esterno Ø15mm	515RON	2
14	Dado - Bolt - Ecrou Mutter - Tuerca - Porca	Autobloccante Flangiato M5	5DADIAFL	8
15	Dado - Bolt - Ecrou Mutter - Tuerca - Porca	Autobloccante Flangiato Alto M8 (H.11mm)	8DADIAFLN	8
16	Dado - Bolt - Ecrou Mutter - Tuerca - Porca	Autobloccante Flangiato M8 (H.9,5mm)	8DADIFN	8
17	Distanziale - Spacer - Entretoise Distanzstueck - Distanciador - Espaçador	-	V900	2
18	Supporto inferiore - Lower support - Support inférieur Soporte inferior - Untere Halterung - Suporte inferior	FRONT SIDE	Z9730SX Z9730DX	2(Left: Right)
19	Supporto inferiore - Lower support - Support inférieur Soporte inferior - Untere Halterung - Suporte inferior	REAR SIDE	Z9731SX Z9731DX	2(Left: Right)
20	Supporto anteriore - Front support -Support avant Vordere Unterstützung - Soporte frontal - Suporte frontal	UPPER SIDE	Z9732SX Z9732DX	2(Left: Right)
21	Supporto anteriore - Front support -Support avant Vordere Unterstützung - Soporte frontal - Suporte frontal	LOWER SIDE	Z9733DX Z9733SX	2(Left: Right)
22	Supporto posteriore - Rear support - Hintere Unterstützung Support arrière - Soporte trasero - Suporte traseiro	UPPER SIDE	Z9734SX Z9734DX	2(Left: Right)
23	Supporto posteriore - Rear support - Hintere Unterstützung Support arrière - Soporte trasero - Suporte traseiro	LOWER SIDE	Z9735SX Z9735DX	2(Left: Right)
24	Componenti Originali - Original Parts -Parties Originales Original Bauteile - Componentes Originales - Componentes Originais			
25	Particolari Inclusi nel 07 RKIT /Components Included In The 07 RKIT Pièces Incluses Dans 07 RKIT / Die Einzelnen Teile Sind Bei 07 RKIT Despieces Incluidos 07 RKIT / Componentes inclusos na 07 RKIT			

PL05138CAM - KL05138CAM

PORTAVALIGIE LATERALE SPECIFICO - SPECIFIC TUBULAR SIDE-CASE HOLDER - PORTE-VALISES LATÉRAUX SPÉCIFIQUE
 SPEZIFISCHES STAHLROHR-SEITENTRAEGER - PORTA MALETAS LATERALES ESPECÍFICO - SUPORTE DE MALAS ESPECÍFICO

BMW S1000XR (2020)

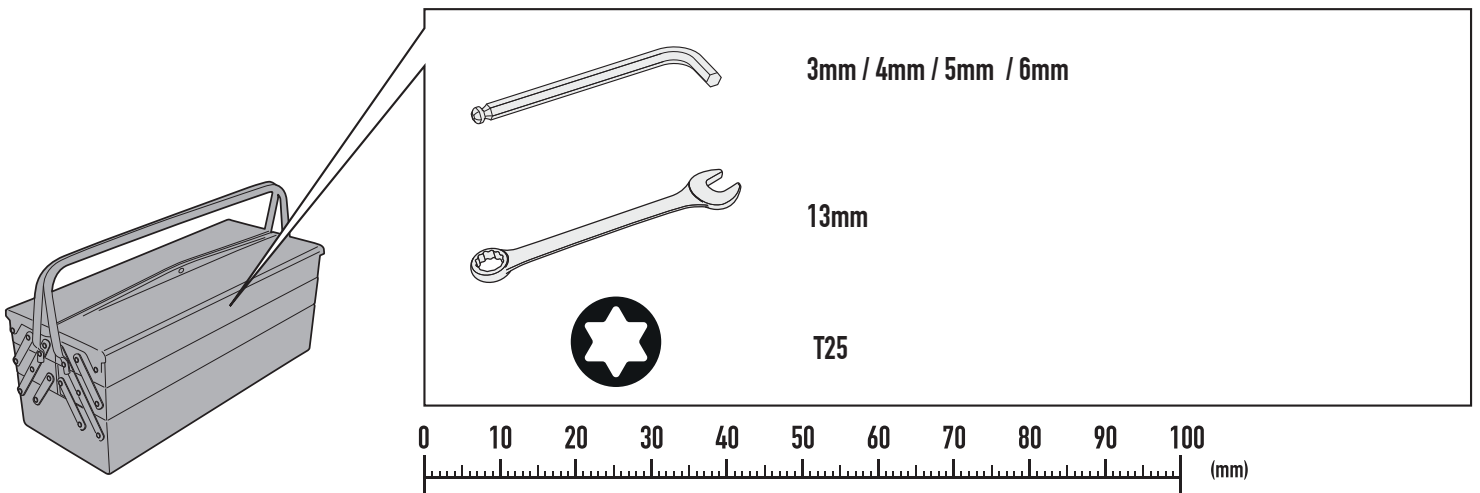
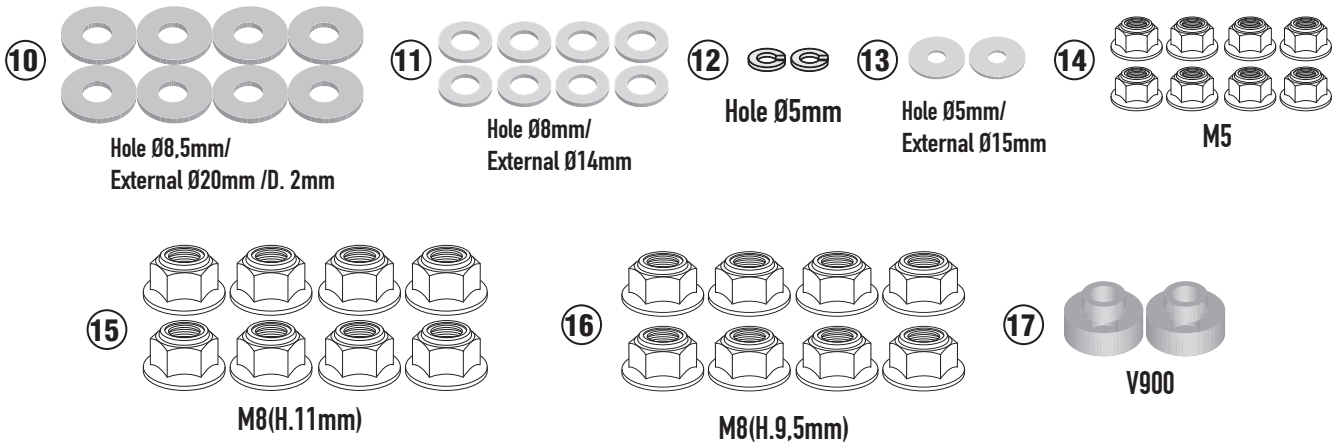
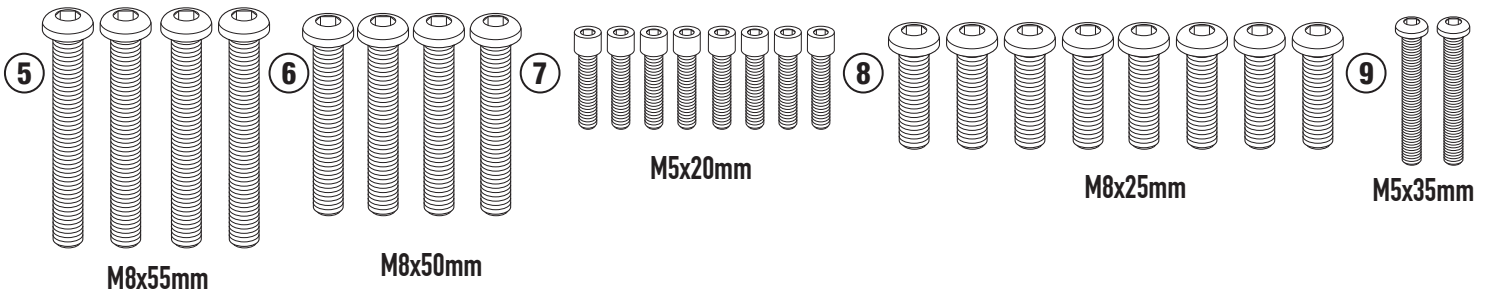
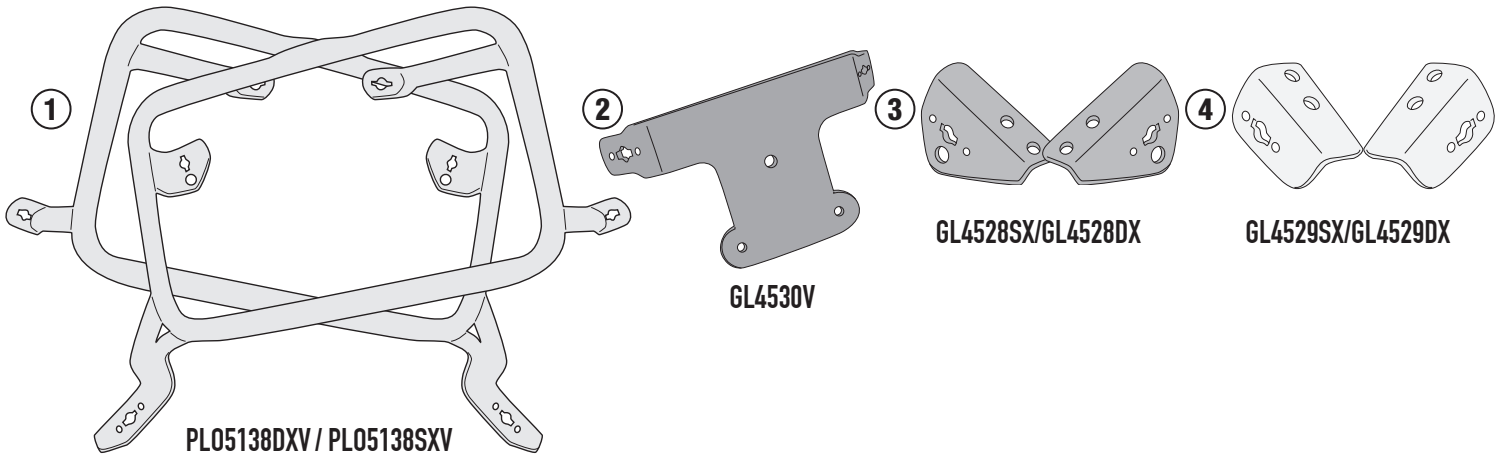

PL05138CAM - KL05138CAM

PORTAVALIGIE LATERALE SPECIFICO - SPECIFIC TUBULAR SIDE-CASE HOLDER - PORTE-VALISES LATÉRAUX SPÉCIFIQUE
 SPEZIFISCHES STAHLROHR-SEITENTRAEGER - PORTA MALETAS LATERALES ESPECÍFICO - SUPORTE DE MALAS ESPECÍFICO

BMW S1000XR (2020)

RIGHT SIDE

18

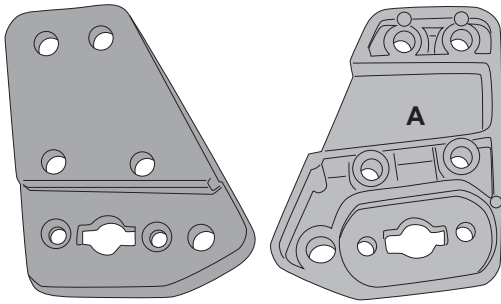

FRONT Z9730DX REAR

LEFT SIDE

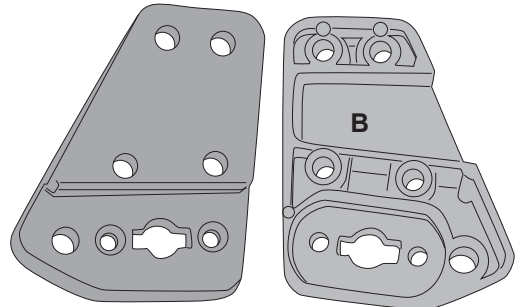

FRONT Z9730SX REAR

RIGHT SIDE

19

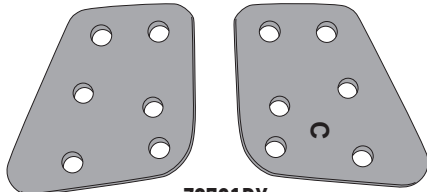

FRONT Z9731DX REAR

LEFT SIDE

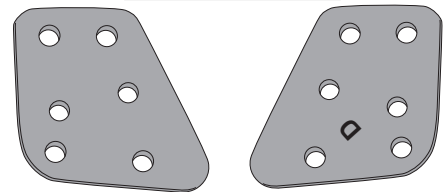

FRONT Z9731SX REAR

RIGHT SIDE

20

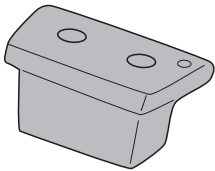

LEFT SIDE

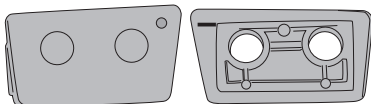
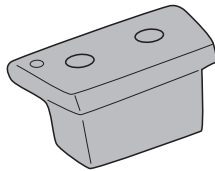

FRONT Z9732DX REAR



FRONT Z9732SX REAR

RIGHT SIDE

21

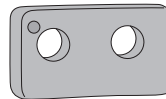

FRONT

LEFT SIDE

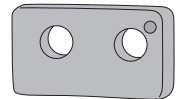

FRONT

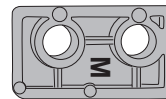

REAR Z9733DX

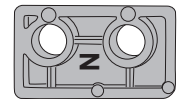

REAR Z9733SX

RIGHT SIDE

22

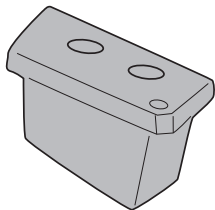

LEFT SIDE

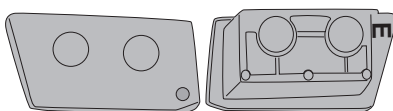
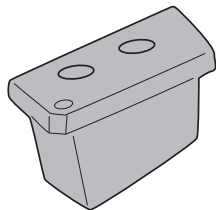

FRONT Z9734DX REAR

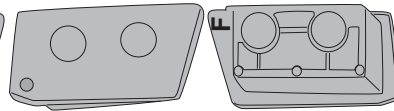

FRONT Z9734SX REAR

RIGHT SIDE

23

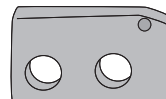

FRONT

LEFT SIDE

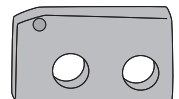

FRONT

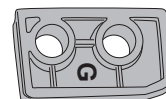

REAR Z9735DX

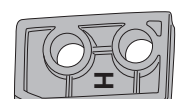

REAR Z9735SX

PL05138CAM - KL05138CAM

PORTAVALIGIE LATERALE SPECIFICO - SPECIFIC TUBULAR SIDE-CASE HOLDER - PORTE-VALISES LATÉRAUX SPÉCIFIQUE
SPEZIFISCHES STAHLROHR-SEITENTRAEGER - PORTA MALETAS LATERALES ESPECÍFICO - SUPORTE DE MALAS ESPECÍFICO

BMW S1000XR (2020)

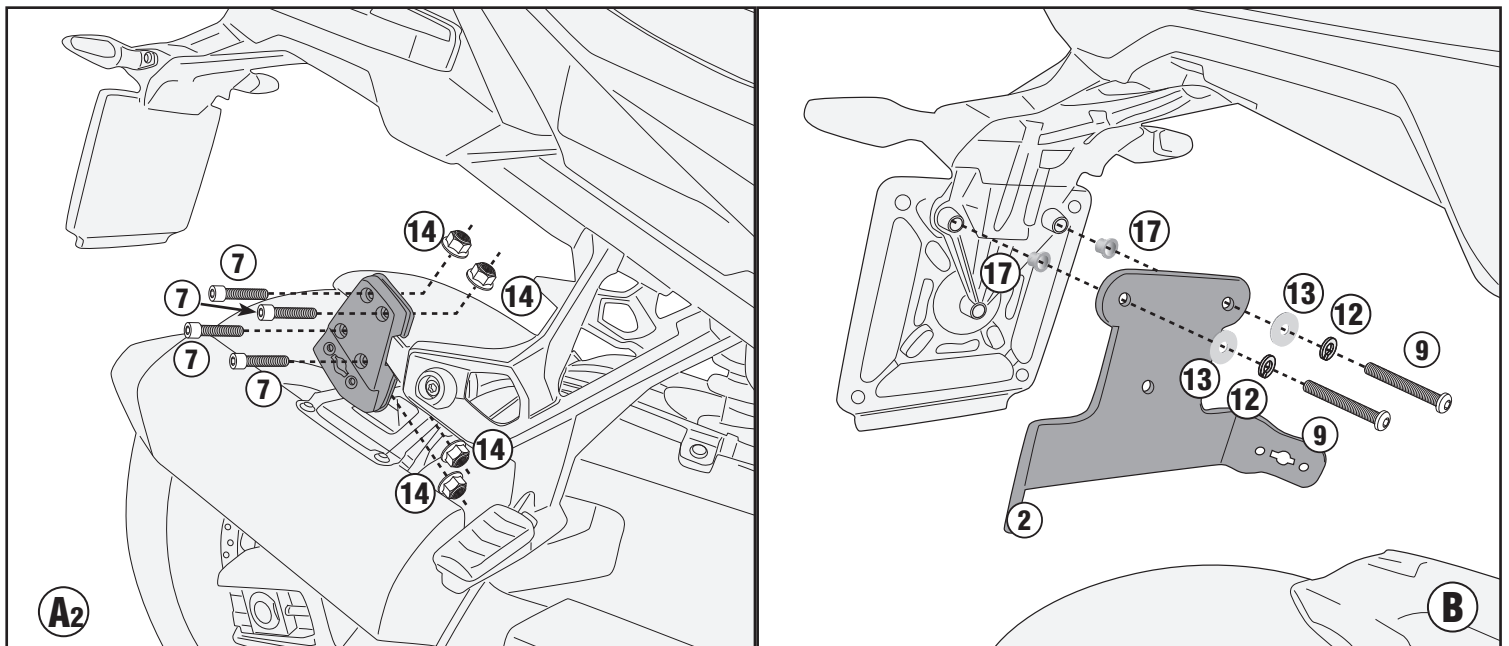
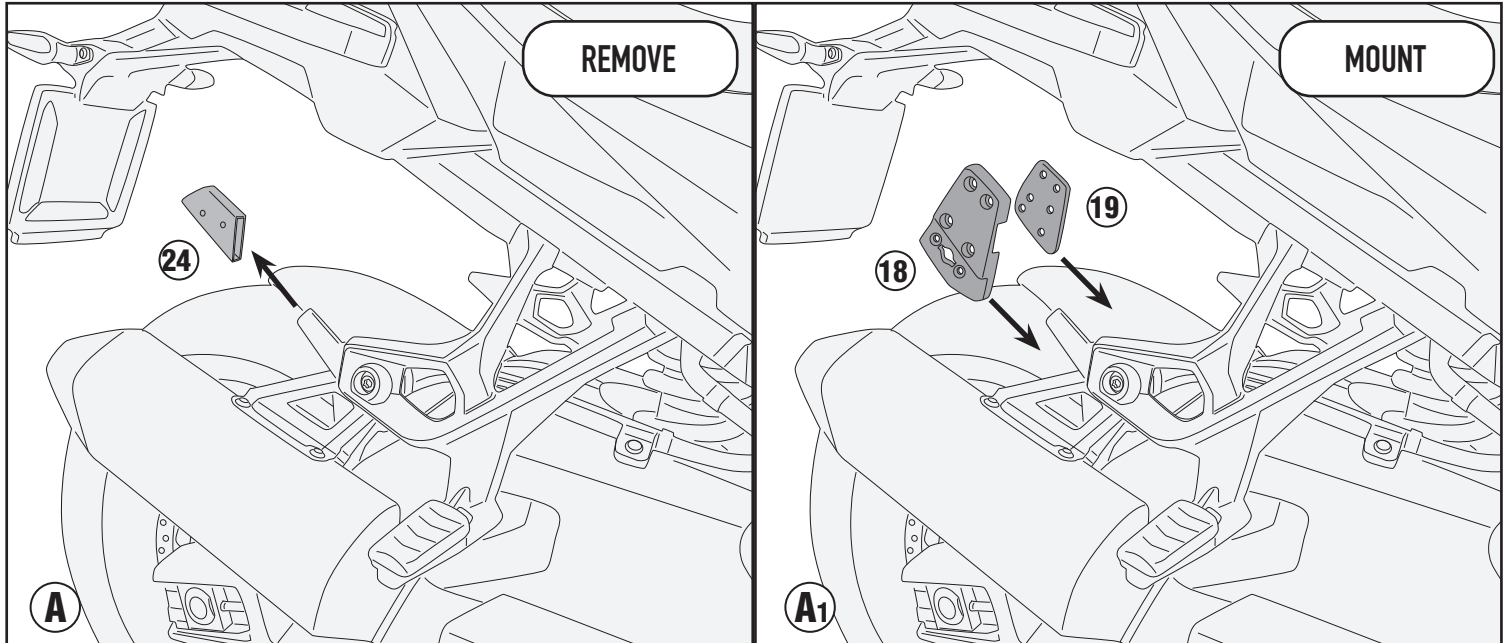

PL05138CAM - KL05138CAM

PORTAVALIGIE LATERALE SPECIFICO - SPECIFIC TUBULAR SIDE-CASE HOLDER - PORTE-VALISES LATÉRAUX SPÉCIFIQUE
 SPEZIFISCHES STAHLROHR-SEITENTRAEGER - PORTA MALETAS LATERALES ESPECÍFICO - SUPORTE DE MALAS ESPECÍFICO

BMW S1000XR (2020)

REMOVE

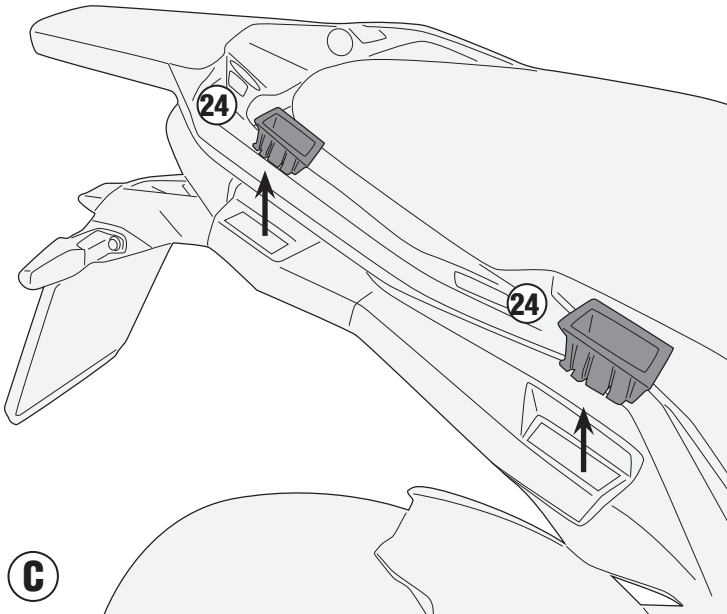

MOUNT

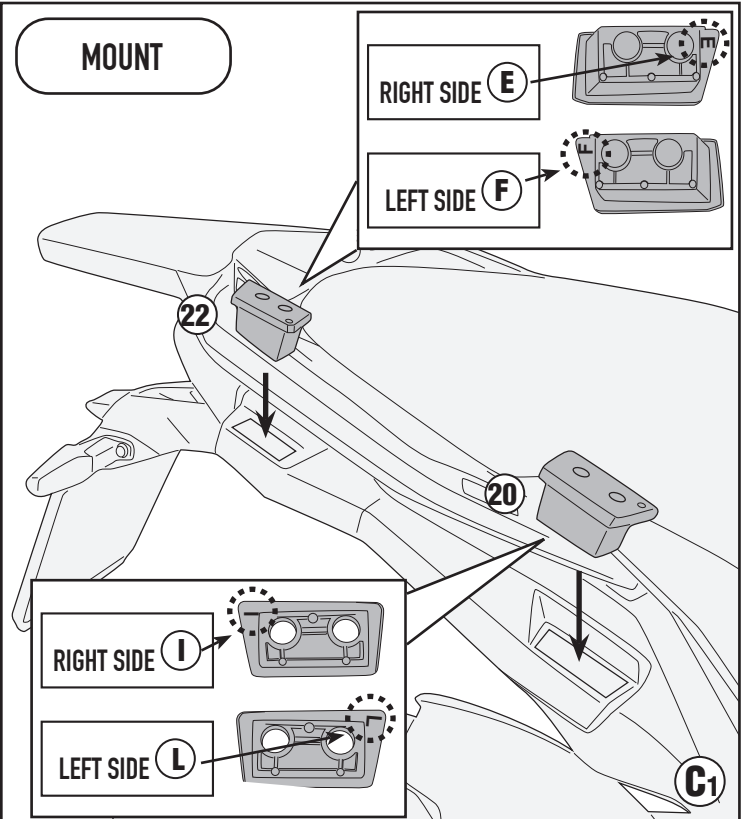

RIGHT SIDE **G**

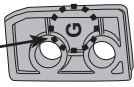

LEFT SIDE **H**

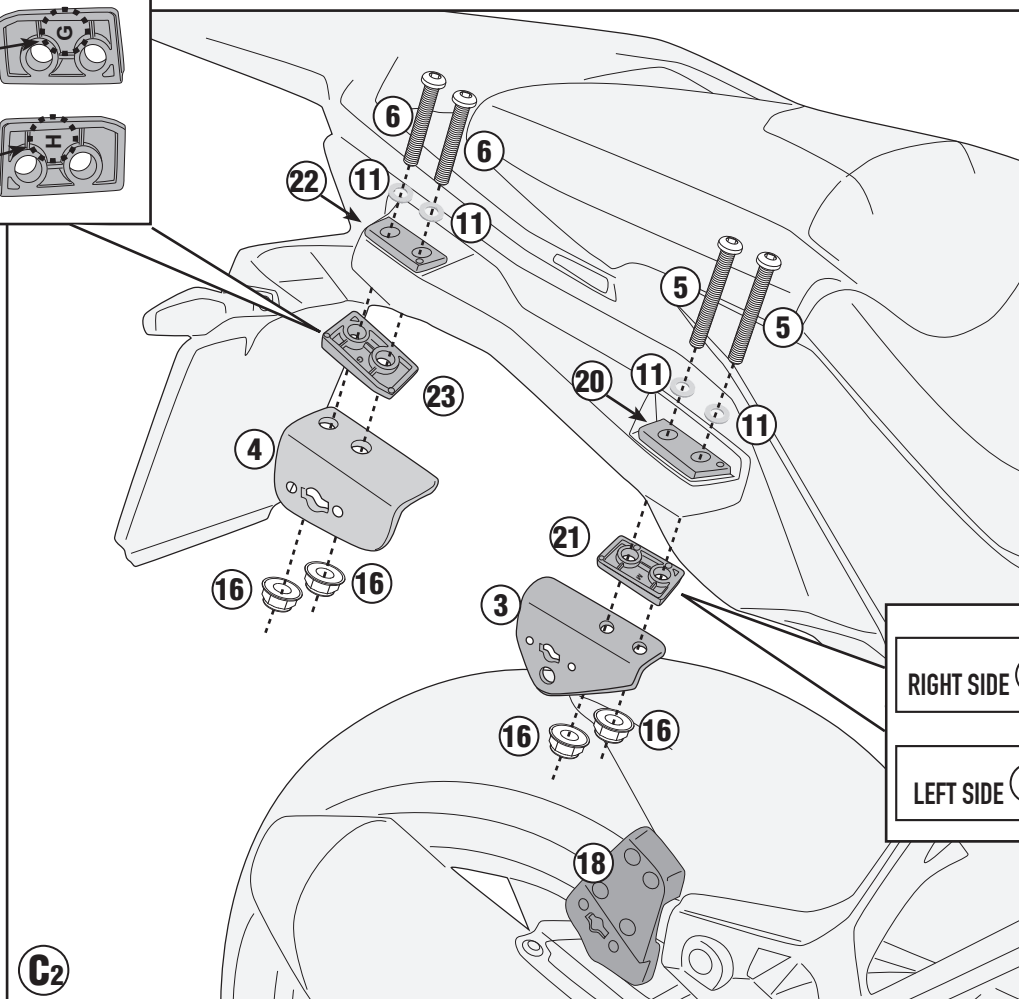
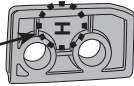

RIGHT SIDE **M**

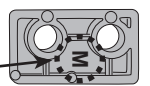

LEFT SIDE **N**

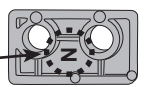

PL05138CAM - KL05138CAM

PORTAVALIGIE LATERALE SPECIFICO - SPECIFIC TUBULAR SIDE-CASE HOLDER - PORTE-VALISES LATÉRAUX SPÉCIFIQUE
SPEZIFISCHES STAHLROHR-SEITENTRAEGER - PORTA MALETAS LATERALES ESPECÍFICO - SUPORTE DE MALAS ESPECÍFICO

BMW S1000XR (2020)

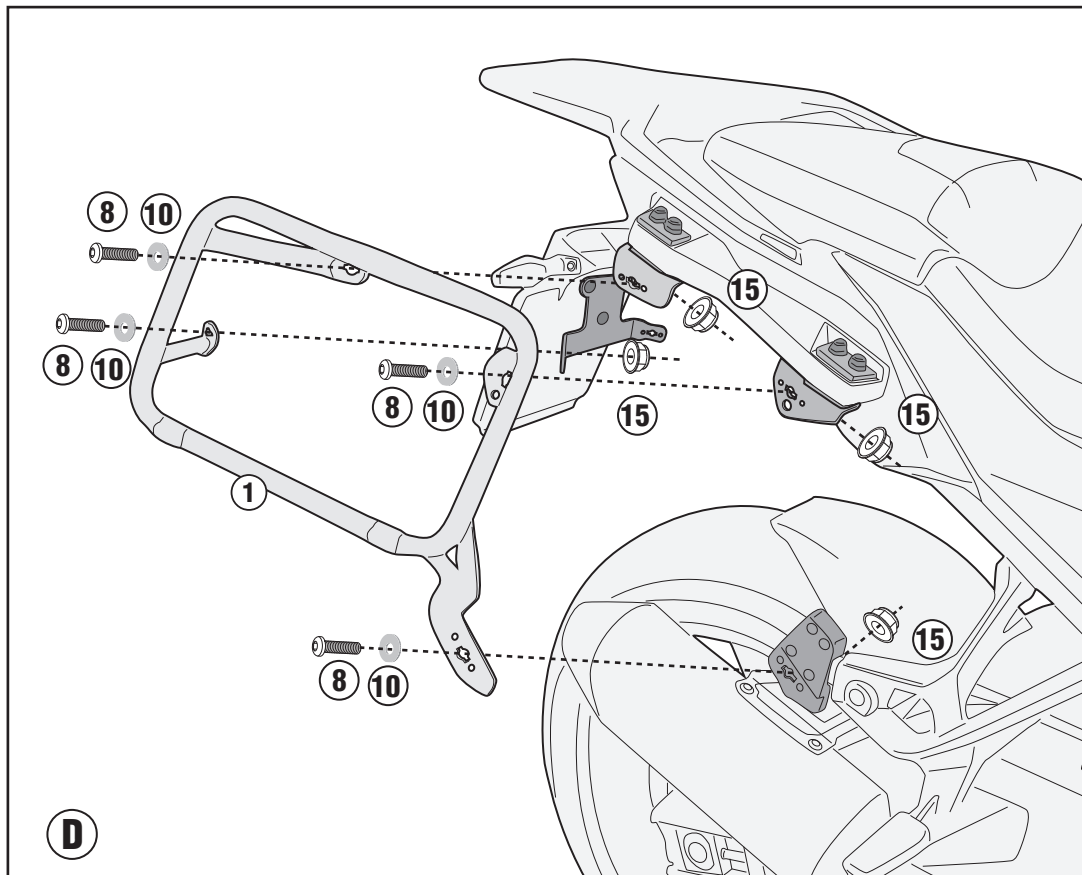

PL05138CAM - KL05138CAM

PORTAVALIGIE LATERALE SPECIFICO - SPECIFIC TUBULAR SIDE-CASE HOLDER - PORTE-VALISES LATÉRAUX SPÉCIFIQUE
SPEZIFISCHES STAHLROHR-SEITENTRÄGER - PORTA MALETAS LATERALES ESPECÍFICO - SUPORTE DE MALAS ESPECÍFICO

BMW S1000XR (2020)

- TRASFORMAZIONE IN PORTAVALIGIE LATERALI RAPID FITTING, AGGIUNDO IL KIT 07RKIT (DA ACQUISTARE SEPARATAMENTE)
- TRANSFORMATION INTO A RAPID FITTING SIDE-CASE HOLDER, BY ADDING THE 07RKIT KIT (TO BE PURCHASED SEPARATELY)
- VERARBEITUNG ZU EINEM SCHNELL MONTIERBAREN SEITENTRÄGER UNTER HINZUFÜGUNG DES 07RKIT-KITS (SEPARAT ZU ERWERBEN)
 - TRANSFORMABLE EN KIT DE FIXATION LATÉRAL RAPIDE, EN AJOUTANT LE KIT 07RKIT (À ACHETER SÉPARÉMENT)
- SE TRANSFORMA EN UN PORTAMALETAS LATERAL DE AJUSTE RÁPIDO, AÑADIENDO EL KIT 07RKIT (SE COMPRA POR SEPARADO)
- CONVERTE EM UM RACK DE PAINEL LATERAL DE ENCAIXE RÁPIDO, ADICIONANDO O KIT 07RKIT (ADQUIRIDO SEPARADAMENTE)

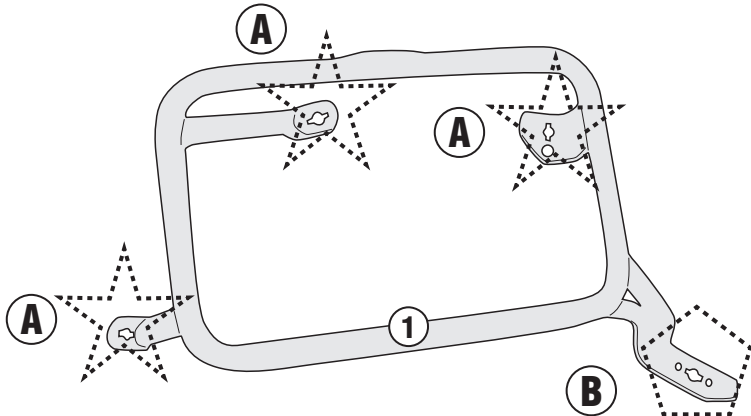

ALWAYS MOUNT THE SCREWS FROM THE OUTSIDE OF THE FRAME



TYPE A

(See the figure above for the correct type)

CORRECT SIDE

INSERT

ATTENTION TO THE
CORRECT ASSEMBLY

GL1432Z

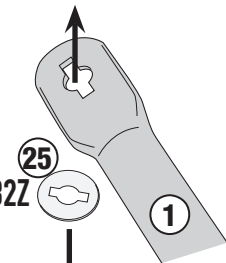

INSERT

25



ATTENTION TO THE
CORRECT ASSEMBLY



Z1957

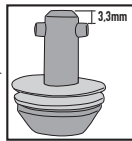

3.3mm

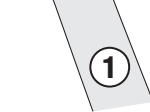

1



TYPE B

(See the figure above for the correct type)

CORRECT SIDE

INSERT

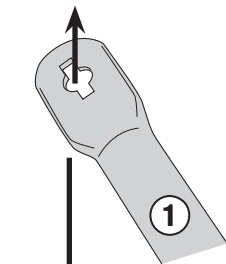
ATTENTION TO THE
CORRECT ASSEMBLY



INSERT

25



ATTENTION TO THE
CORRECT ASSEMBLY

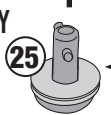

Z2173

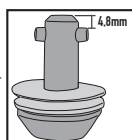

4.8mm

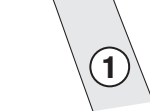

1

PL05138CAM - KL05138CAM

PORTAVALIGIE LATERALE SPECIFICO - SPECIFIC TUBULAR SIDE-CASE HOLDER - PORTE-VALISES LATÉRAUX SPÉCIFIQUE
SPEZIFISCHES STAHLROHR-SEITENTRAEGER - PORTA MALETAS LATERALES ESPECÍFICO - SUORTE DE MALAS ESPECÍFICO

BMW S1000XR (2020)

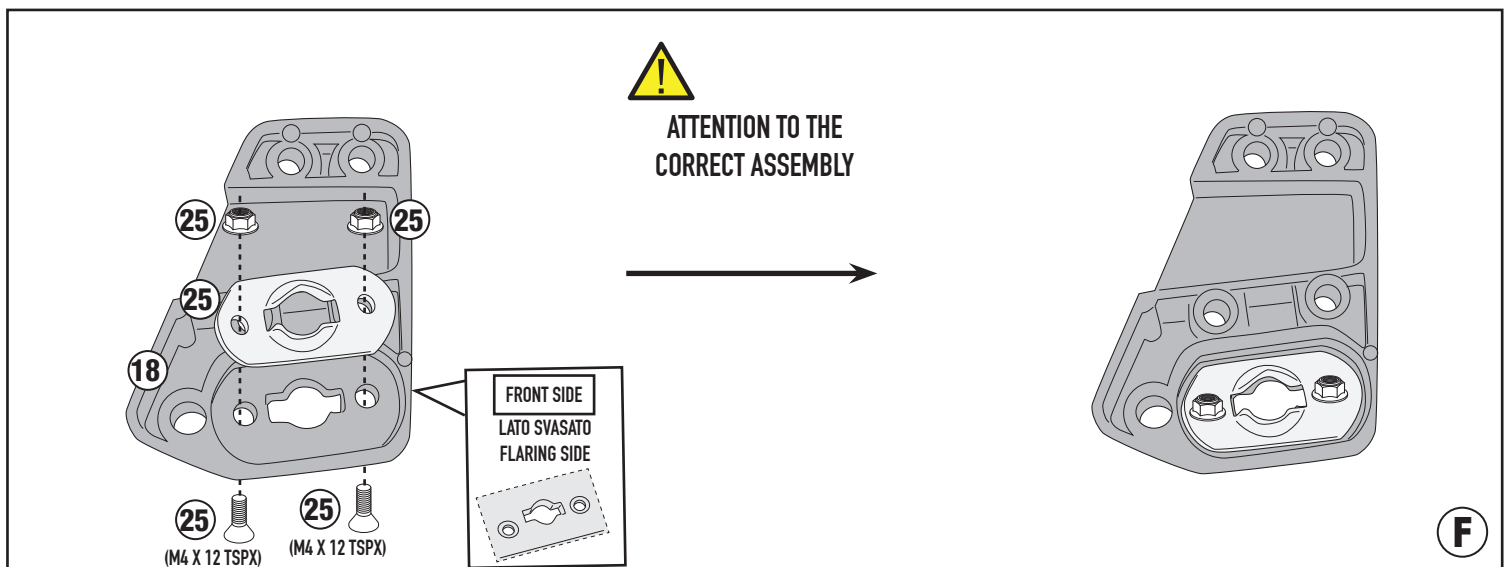
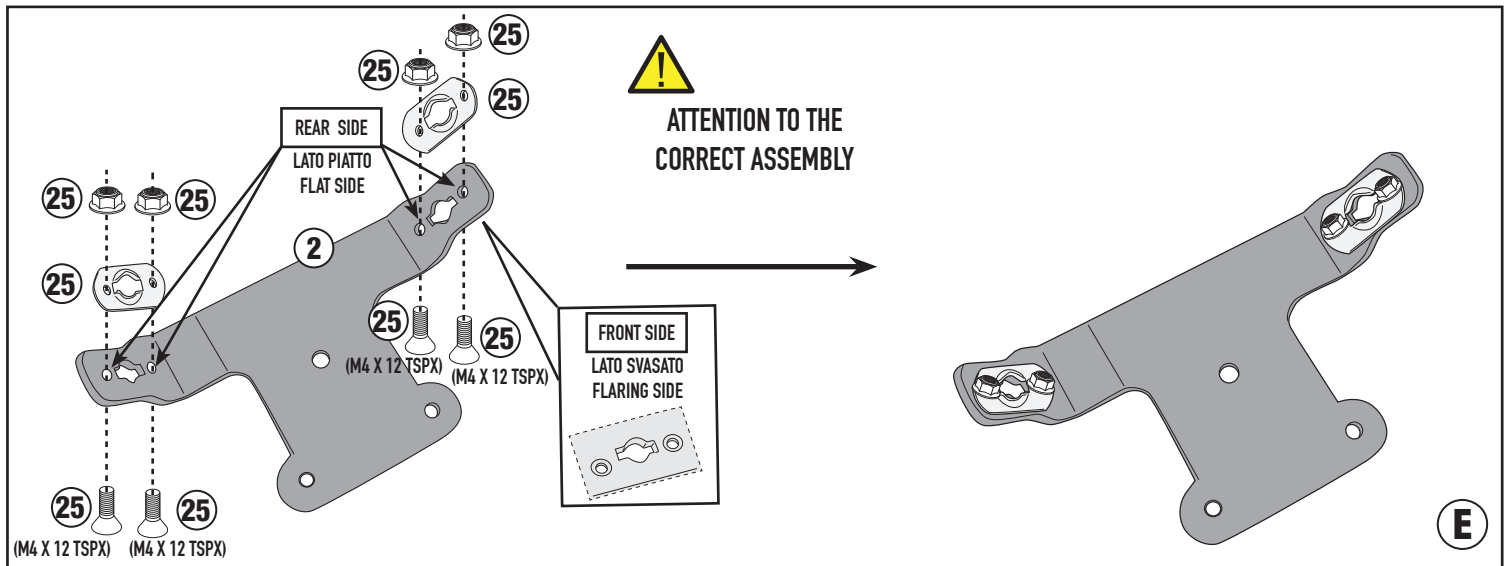
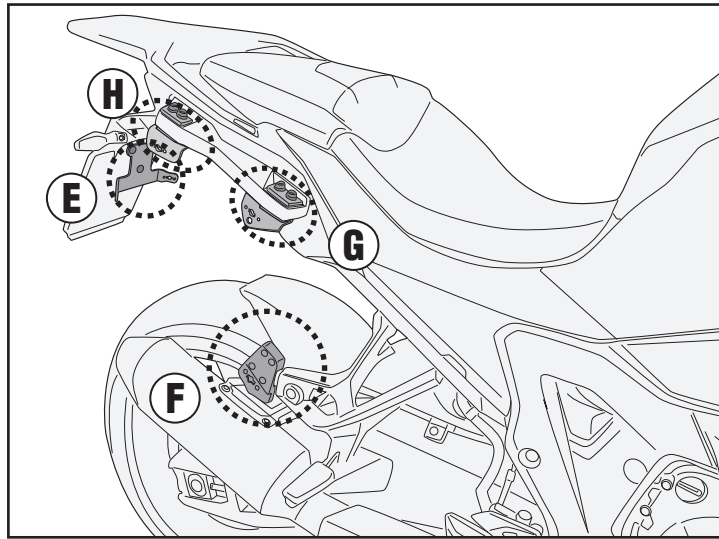

PL05138CAM - KL05138CAM

PORTAVALIGIE LATERALE SPECIFICO - SPECIFIC TUBULAR SIDE-CASE HOLDER - PORTE-VALISES LATÉRAUX SPÉCIFIQUE
SPEZIFISCHES STAHLROHR-SEITENTRAEGER - PORTA MALETAS LATERALES ESPECÍFICO - SUPORTE DE MALAS ESPECÍFICO

BMW S1000XR (2020)

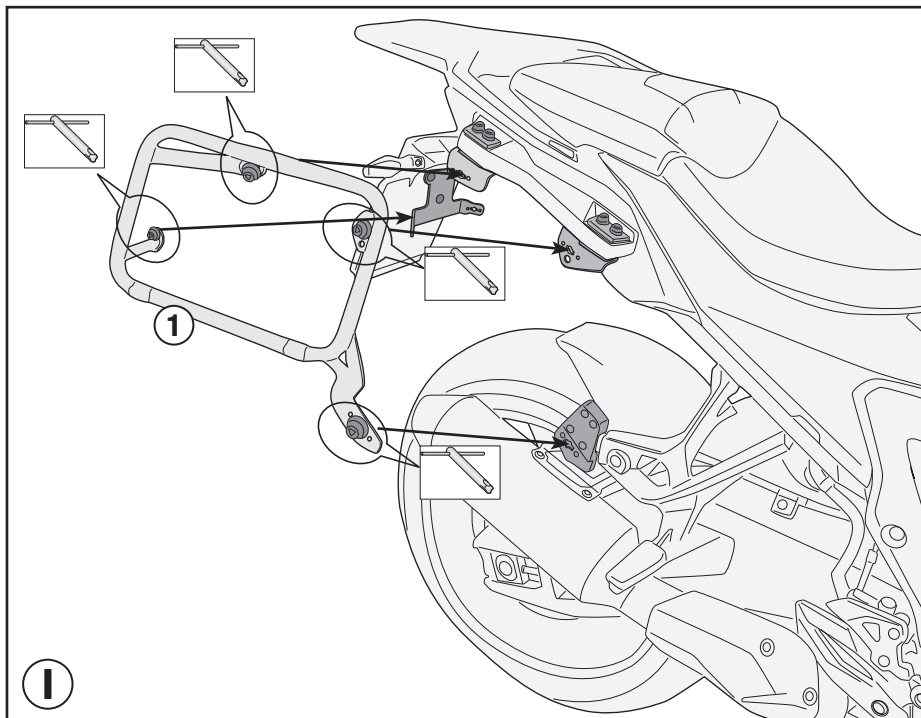
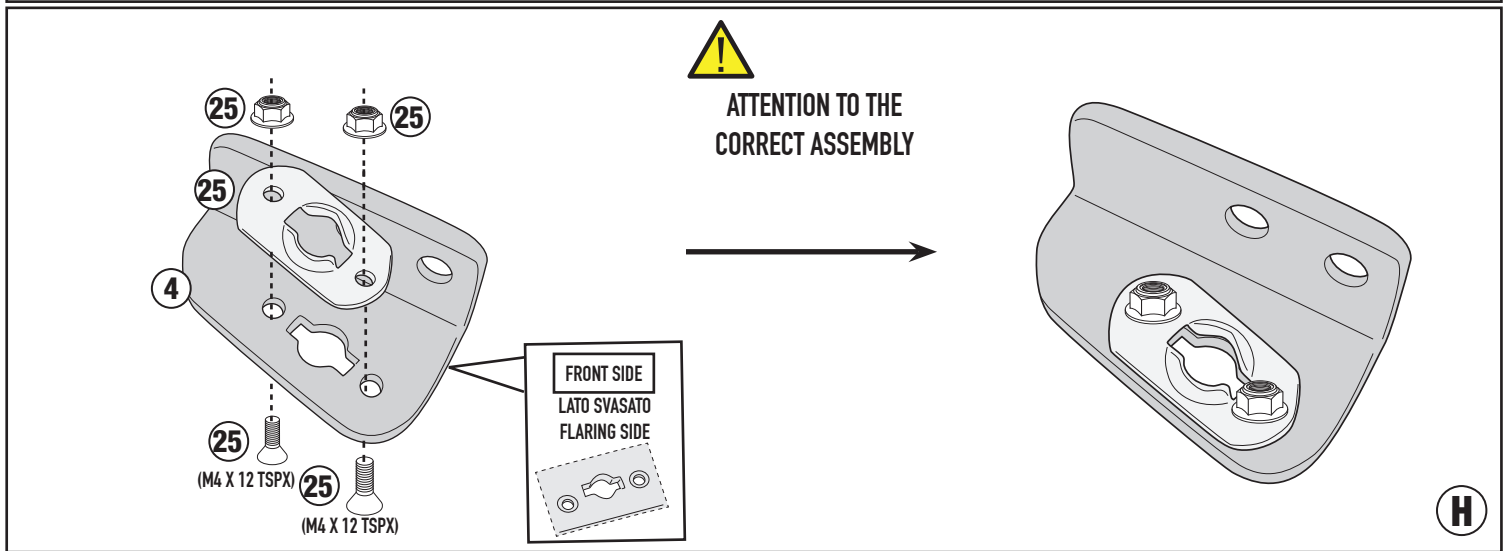
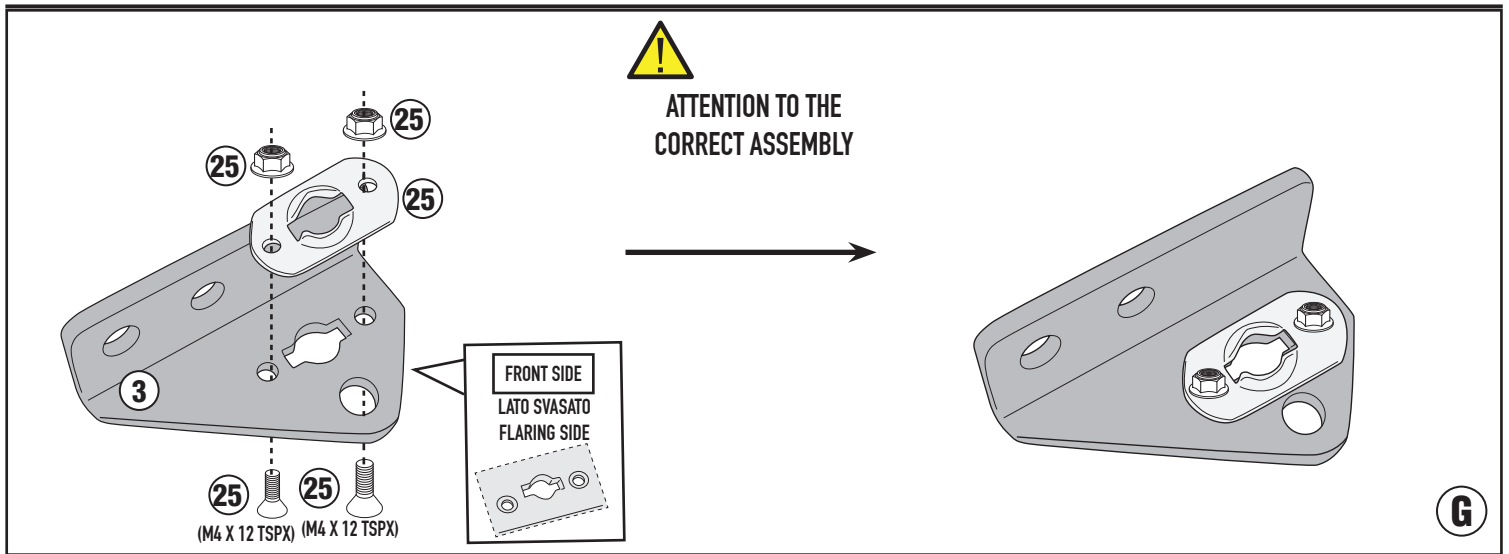

MONTAGGIO/SMONTAGGIO - ASSEMBLY/DISASSEMBLY - MONTAGE / DÉMONTAGE - MONTAGE / DEMONTAGE - MONTAJE / DESMONTAJE - MONTAGEM / DESMONTAGEM

RAPID FITTING

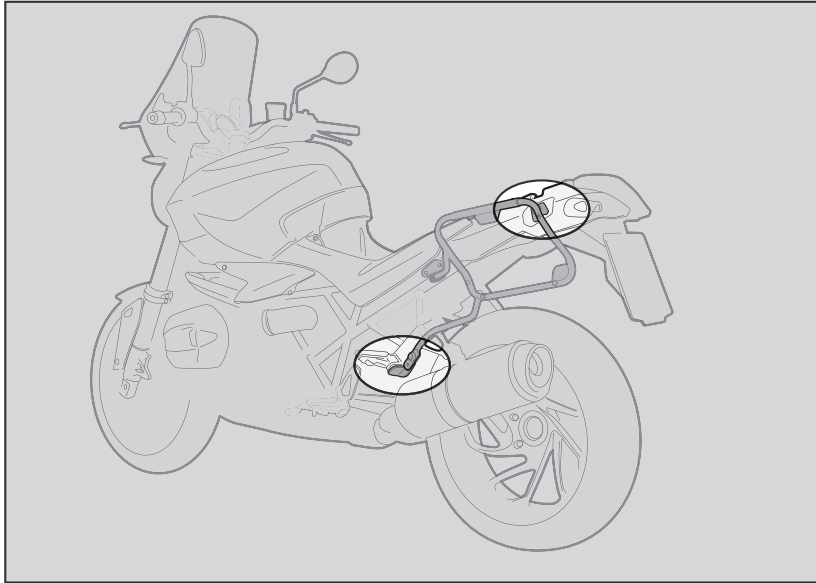

1. INSERIRE L'ATTREZZO NELLA TESTA DELLA VITE SPECIALE;
2. RUOTARE DI 1/4 DI GIRO IN SENSO ORARIO FINO A CHE LA ROTAZIONE NON TERMINA E SI AVVERTE LO SCATTO;
3. PER SMONTARE PROCEDERE IN SENSO INVERSO.

1. INSERT THE SPECIAL KEY INTO THE HEAD OF THE SCREW;
2. TURN THE KEY ¼ TURN CLOCKWISE UNTIL ROTATION STOPS AND THE SIDE CASE HOLDER IS FASTENED SECURELY TO THE FITMENT POINT;
3. IN ORDER TO DISASSEMBLE THE BRACKETRY PERFORM THE OPERATION IN REVERSE.

1. INSERER LA CLE SPECIALE DANS LA TÊTE DE LA VIS;
2. VISSER D'¼ DE TOUR DANS LE SENS HORAIRE JUSQU'AU BLOCAGE DE LA VIS POUR MONTER EN TOUTE SECURITE LE SUPPORT A SON POINT DE FIXATION;
3. POUR LE DEMONTAGE, PROCEDER EN SENSE INVERSE.

1. STECKEN SIE DAS WERKZEUG IN DEN KOPF DER SPEZIFISCHEN SCHRAUBE;
2. DREHEN SIE DIE SCHRAUBE 1 / 4 UMDREHUNG IM UHRZEIGERSINN BIS SIE BEMERKEN, DASS DIE SCHRAUBE IM BEFESTIGUNGSPUNKT EINGEKLEMMT IST;
3. FÜR DIE DEMONTAGE FOLGEN SIE DEN HINWEISE UMGEKEHRT.

1. INSERTAR LA LLAVE ESPECIAL EN LA CABEZA DEL TORNILLO
2. DAR ¼ DE VUELTA EN EL SENTIDO HORARIO HASTA QUE LLEGUE AL TOPE Y SE VEA EL TORNILLO;
3. PARA DESMONTARLO PROCEDER EN LA DIRECCIÓN CONTRARIA;

MONTAGGIO - ASSEMBLY - MONTAGE - MONTAGE - MONTAJE

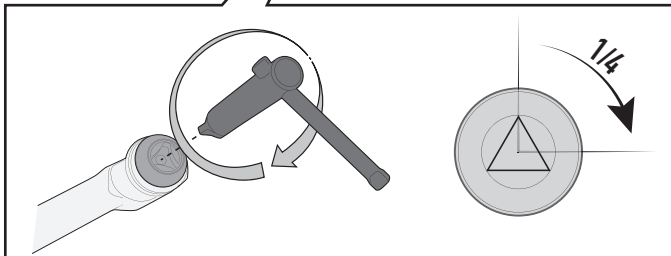
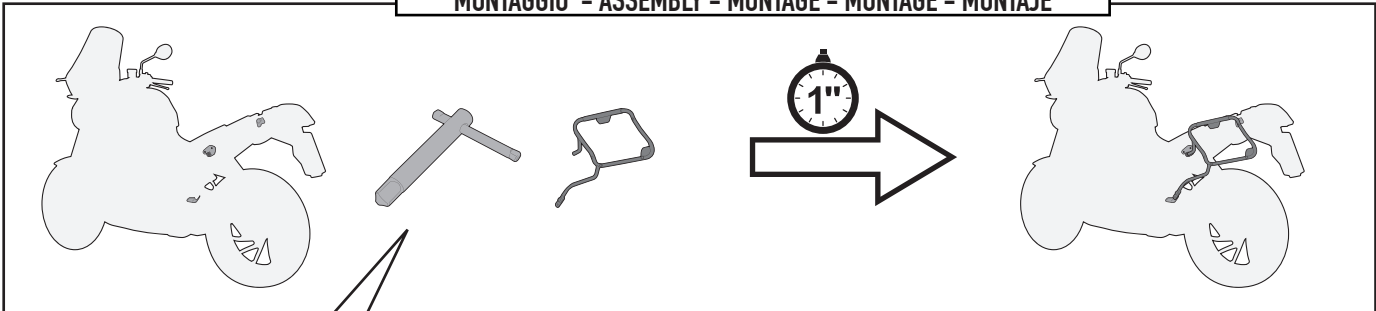

SMONTAGGIO - DISASSEMBLY - DÉMONTAGE - DEMONTAGE - DESMONTAJE

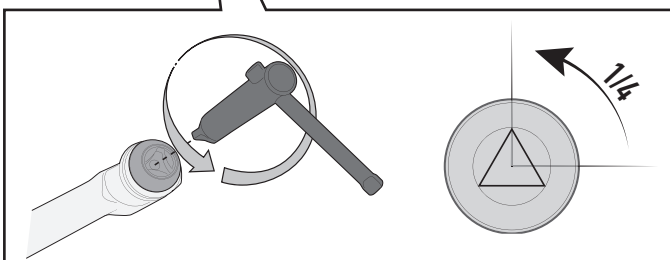
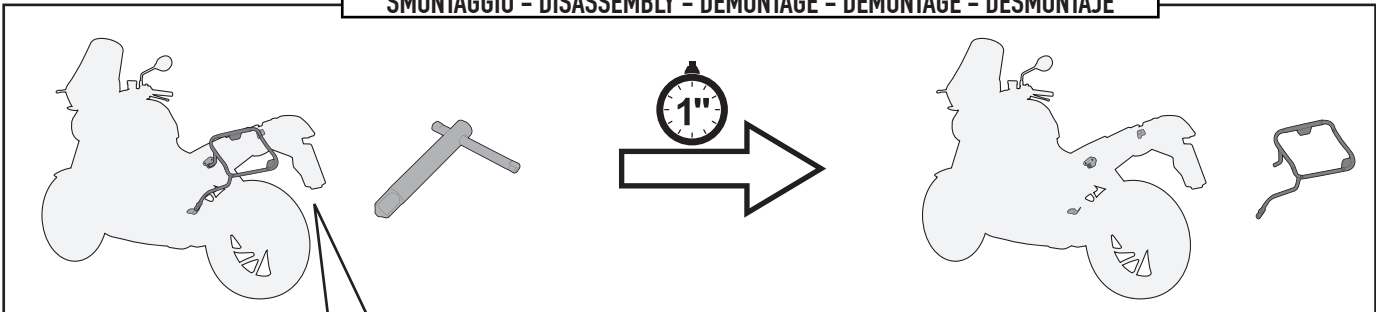

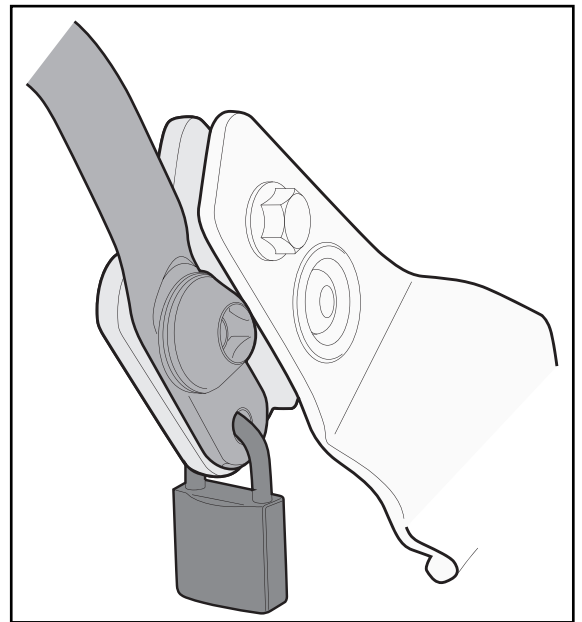
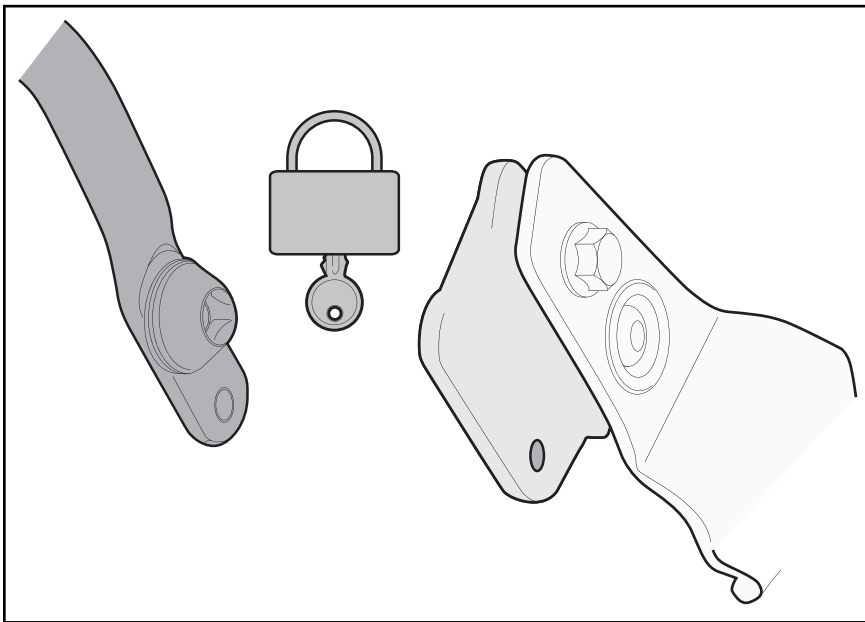
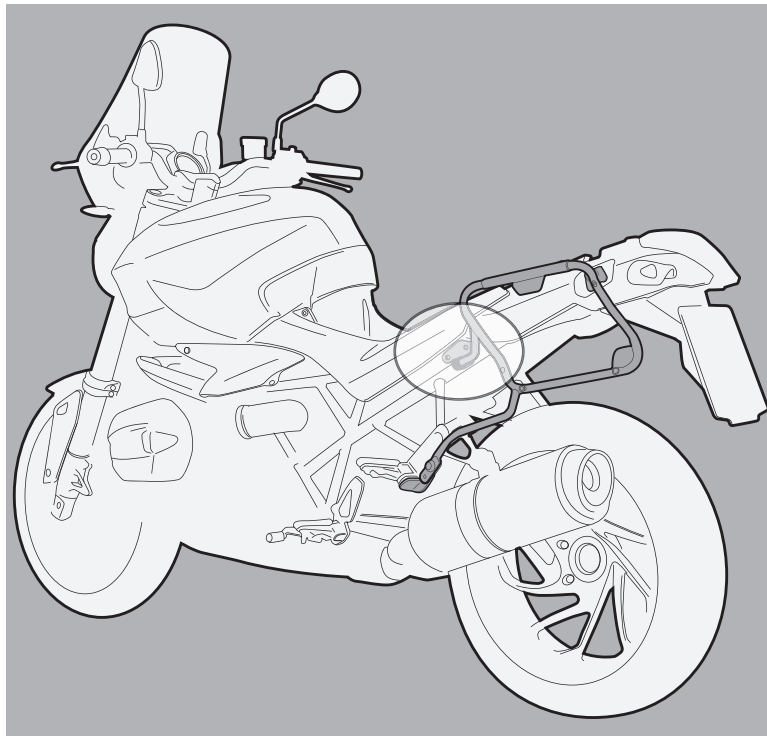

FORO DI SICUREZZA

FORO PREDISPOSTO AD ASSICURARE IL PORTAVALIGIE LATERALE ALLA MOTO (CON UN LUCCHETTO PER ESEMPIO, NON INCLUSO).

SECURITY HOLE

HOLE PLACEMENT IN ORDER TO INCREASE SECURITY OF THE TUBULAR SIDE-CASE HOLDER TO THE MOTORCYCLE (WITH A LOCK, FOR EXAMPLE, NOT INCLUDED).

TROU DE SECURITE

TROU PREDISPOSE POUR ASSURER LE PORTE-VALISE LATERAL A LA MOTO (AVEC UN CADENAS PAR EXEMPLE, NON INCLUS).

SICHERHEITSLÖCH

VORGESEHENES LOCH UM DEN SEITENKOFFER TRÄGER AN DEM FAHRZEUG ZU SICHERN (Z. B. MIT EINEM VORHÄNGESCHLOSS, NICHT ENTHALTEN);

ORIFICIO DE SEGURIDAD

ESTE ORIFICIO ESTA CREADO PARA ASEGURAR EL PORTAEQUIPAJES LATERAL A LA MOTO (POR EJEMPLO CON UN CANDADO, QUE NO ESTÁ INCLUIDO).